



Dell™ Inspiron™ 1410 Service Manual

[Before You Begin](#)
[Module Cover](#)
[Memory Module](#)
[Mini-Cards](#)
[Center Control Cover](#)
[Keyboard](#)
[Display](#)
[Palm Rest](#)
[System Fan](#)
[Processor Heat Sink](#)

[Processor](#)
[Hard Drive](#)
[Coin-Cell Battery](#)
[Optical Drive](#)
[Speaker](#)
[Internal Card With Bluetooth® Wireless Technology](#)
[System Board](#)
[Battery Latch Assembly](#)
[Flashing the BIOS](#)

Notes, Notices, and Cautions

-  **NOTE:** A NOTE indicates important information that helps you make better use of your computer.
 -  **NOTICE:** A NOTICE indicates either potential damage to hardware or loss of data and tells you how to avoid the problem.
 -  **CAUTION:** A CAUTION indicates a potential for property damage, personal injury, or death.
-

Information in this document is subject to change without notice.
© 2008 Dell Inc. All rights reserved.

Reproduction of these materials in any manner whatsoever without the written permission of Dell Inc. is strictly forbidden.

Trademarks used in this text: *Dell*, the *DELL* logo, and *Inspiron* are trademarks of Dell Inc.; *Bluetooth* is a registered trademark owned by Bluetooth SIG, Inc. and is used by Dell under license. *Microsoft*, *Windows*, *Windows Vista*, and *Windows Vista start button* are either trademarks or registered trademarks of Microsoft Corporation in the United States and/or other countries.

Other trademarks and trade names may be used in this document to refer to either the entities claiming the marks and names or their products. Dell Inc. disclaims any proprietary interest in trademarks and trade names other than its own.

Model PP38L

August 2008 Rev. A00

[Back to Contents Page](#)

Module Cover

Dell™ Inspiron™ 1410 Service Manual

- [Removing the Module Cover](#)
- [Replacing the Module Cover](#)

CAUTION: Before working inside your computer, read the safety information that shipped with your computer. For additional safety best practices information, see the [Regulatory Compliance Homepage](http://www.dell.com/regulatory_compliance) at www.dell.com/regulatory_compliance.

NOTICE: To avoid electrostatic discharge, ground yourself by using a wrist grounding strap or by periodically touching an unpainted metal surface (such as a connector on the back of the computer).

Removing the Module Cover

1. Follow the procedures in [Before You Begin](#).
2. Turn the computer over.
3. Remove the two screws from the module cover.

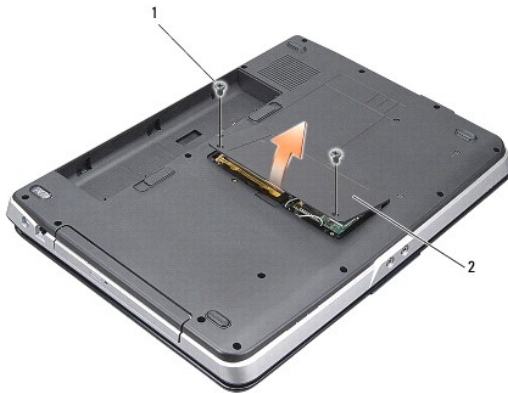

1	module cover screw (2)	2	module cover
---	------------------------	---	--------------

4. Lift the module cover away from the computer.
-

Replacing the Module Cover

1. Replace the module cover.
 2. Replace the two screws on the module cover.
 3. Slide the battery into the battery bay, until it clicks into place.
-

[Back to Contents Page](#)

Battery Latch Assembly

Dell™ Inspiron™ 1410 Service Manual

- [Removing the Battery Latch Assembly](#)
- [Replacing the Battery Latch Assembly](#)

⚠ CAUTION: Before working inside your computer, read the safety information that shipped with your computer. For additional safety best practices information, see the [Regulatory Compliance Homepage](http://www.dell.com/regulatory_compliance) at www.dell.com/regulatory_compliance.

➡ NOTICE: To avoid electrostatic discharge, ground yourself by using a wrist grounding strap or by periodically touching a connector on the back panel of the computer.

Removing the Battery Latch Assembly

1. Follow the instructions in [Before You Begin](#).
1. Remove the system board (see [System Board](#)).
2. Remove the screw from the battery-lock latch and remove it.
3. Remove the screw from the battery-bay release latch.
- ➡ NOTICE:** Before you remove the battery release button, observe the orientation of the button to ensure proper installation when the button is replaced.
4. Slide the battery latch assembly to the right to remove it.
5. Unhook the latch spring from the latch.

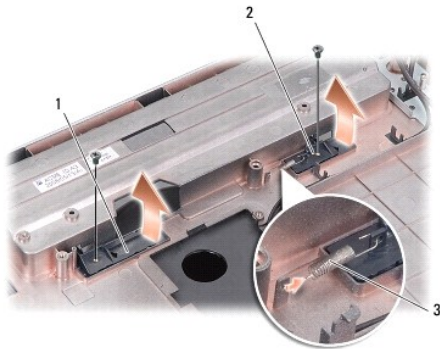

1	battery-lock latch	2	battery-bay release latch
3	latch spring		

Replacing the Battery Latch Assembly

➡ NOTICE: Ensure the battery latch assembly is properly oriented. The indent for the button should face up when installing the assembly.

1. Replace the spring and slide the battery latch assembly into place.
 2. Replace and tighten the screws.
 3. Replace the system board (see [Replacing the System Board](#)).
 4. Slide the battery into the battery bay, until it clicks in place.
-

[Back to Contents Page](#)

[Back to Contents Page](#)

Before You Begin

Dell™ Inspiron™ 1410 Service Manual

- [Recommended Tools](#)
- [Turning Off Your Computer](#)
- [Before Working Inside Your Computer](#)

This section provides procedures for removing and installing the components in your computer. Unless otherwise noted, each procedure assumes that the following conditions exist:

- 1 You have performed the steps in [Turning Off Your Computer](#) and [Before Working Inside Your Computer](#).
- 1 You have read the safety information shipped with your computer.
- 1 A component can be replaced or—if purchased separately—installed by performing the removal procedure in reverse order.



Recommended Tools

The procedures in this document may require the following tools:

- 1 Small flat-blade screwdriver
- 1 Phillips screwdriver
- 1 Flash BIOS update program CD

Turning Off Your Computer

 **NOTICE:** To avoid losing data, save and close all open files and exit all open programs before you turn off your computer.

1. Save and close all open files and exit all open programs.
2. Click **Start** , click the arrow , and then click **Shut Down**.

The computer turns off after the operating system shutdown process finishes.

3. Ensure that the computer and all attached devices are turned off. If your computer and attached devices did not automatically turn off when you shut down your operating system, press and hold the power button until the computer turns off.

Before Working Inside Your Computer

Use the following safety guidelines to help protect your computer from potential damage and to help to ensure your own personal safety.

 **CAUTION:** Before working inside your computer, read the safety information that shipped with your computer. For additional safety best practices information, see the [Regulatory Compliance Homepage](http://www.dell.com/regulatory_compliance) at www.dell.com/regulatory_compliance.

 **NOTICE:** Handle components and cards with care. Do not touch the components or contacts on a card. Hold a card by its edges or by its metal mounting bracket. Hold a component such as a processor by its edges, not by its pins.

 **NOTICE:** Only a certified service technician should perform repairs on your computer. Damage due to servicing that is not authorized by Dell is not covered by your warranty.

 **NOTICE:** When you disconnect a cable, pull on its connector or on its pull-tab, not on the cable itself. Some cables have connectors with locking tabs; if you are disconnecting this type of cable, press in on the locking tabs before you disconnect the cable. As you pull connectors apart, keep them evenly aligned to avoid bending any connector pins. Also, before you connect a cable, ensure that both connectors are correctly oriented and aligned.

 **NOTICE:** To avoid damaging the computer, perform the following steps before you begin working inside the computer.

1. Ensure that the work surface is flat and clean to prevent the computer cover from being scratched.
2. Turn off your computer (see [Turning Off Your Computer](#)).

 **NOTICE:** To disconnect a network cable, first unplug the cable from your computer and then unplug the cable from the network device.

3. Disconnect all telephone or network cables from the computer.

4. Close the display and turn the computer upside down on a flat work surface.
5. Disconnect your computer and all attached devices from their electrical outlets.

➔ **NOTICE:** To avoid damaging the system board, you must remove the main battery before you service the computer.

➔ **NOTICE:** To avoid damage to the computer, use only the battery designed for this particular Dell computer. Do not use batteries designed for other Dell computers.

6. Remove the main battery:
 - a. Unlock the battery by sliding the battery-lock latch towards the outer edge.
 - b. Slide the battery-bay release latch and hold it.
 - c. Remove the battery from the battery bay.

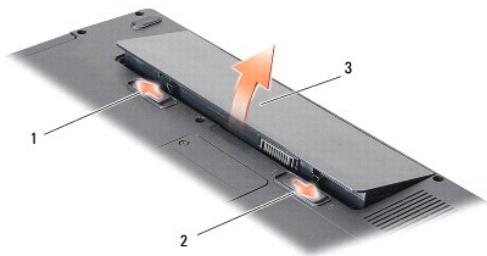

1	battery-lock latch	2	battery-bay release latch
3	battery		

7. Press the power button to ground the system board.
-

[Back to Contents Page](#)

Flashing the BIOS

Dell™ Inspiron™ 1410 Service Manual

- [Flashing the BIOS From a CD](#)
- [Flashing the BIOS From the Hard Drive](#)

If a BIOS-update program CD is provided with the new system board, flash the BIOS from the CD. If you do not have a BIOS-update program CD, flash the BIOS from the hard drive.

Flashing the BIOS From a CD

1. Ensure that the AC adapter is plugged in and that the main battery is installed properly.

 **NOTE:** If you use a BIOS-update program CD to flash the BIOS, set up the computer to boot from a CD before inserting the CD.

2. Insert the BIOS-update program CD, and restart the computer.

Follow the instructions that appear on the screen. The computer continues to boot and updates the new BIOS. When the flash update is complete, the computer will automatically reboot.

3. Press <F2> during POST to enter the system setup program.
 4. Press <Alt><f> to reset the computer defaults.
 5. Press <Esc>, select **Save changes and reboot**, and press <Enter> to save configuration changes.
 6. Remove the BIOS-update program CD from the drive and restart the computer.
-

Flashing the BIOS From the Hard Drive

1. Ensure that the AC adapter is plugged in, the main battery is properly installed, and a network cable is attached.
 2. Turn on the computer.
 3. Locate the latest BIOS update file for your computer at support.dell.com.
 4. Click **Download Now** to download the file.
 5. If the **Export Compliance Disclaimer** window appears, click **Yes, I Accept this Agreement**.
The **File Download** window appears.
 6. Click **Save this program to disk** and then click **OK**.
The **Save In** window appears.
 7. Click the down arrow to view the **Save In** menu, select **Desktop**, and then click **Save**.
The file downloads to your desktop.
 8. Click **Close** if the **Download Complete** window appears.
The file icon appears on your desktop and is titled the same as the downloaded BIOS update file.
 9. Double-click the file icon on the desktop and follow the instructions on the screen.
-

Internal Card With Bluetooth® Wireless Technology

Dell™ Inspiron™ 1410 Service Manual

- [Removing the Bluetooth® Card](#)
- [Replacing the Bluetooth® Card](#)

CAUTION: Before working inside your computer, read the safety information that shipped with your computer. For additional safety best practices information, see the Regulatory Compliance Homepage at www.dell.com/regulatory_compliance.

NOTICE: To avoid electrostatic discharge, ground yourself by using a wrist grounding strap or by periodically touching an unpainted metal surface (such as the back panel) on the computer.

Removing the Bluetooth® Card

1. Follow the instructions in [Before You Begin](#).
2. Remove the palm rest (see [Palm Rest](#)).
3. Remove the bluetooth card cable connector from the system board.
4. Gently lift the bluetooth card from the bluetooth card compartment on the computer base.



1	bluetooth card cable	2	bluetooth card
3	bluetooth card compartment	4	bluetooth card cable connector

Replacing the Bluetooth® Card

1. Replace the bluetooth card in the compartment in the computer base.
2. Replace the bluetooth cable connector to the system board.
3. Follow the instructions in [Replacing the Palm Rest](#).
4. Slide the battery into the battery bay, until it clicks in place.

[Back to Contents Page](#)

Coin-Cell Battery

Dell™ Inspiron™ 1410 Service Manual

- [Removing the Coin-Cell Battery](#)
- [Replacing the Coin-Cell Battery](#)

- ⚠ CAUTION:** Before working inside your computer, read the safety information that shipped with your computer. For additional safety best practices information, see the [Regulatory Compliance Homepage](http://www.dell.com/regulatory_compliance) at www.dell.com/regulatory_compliance.
- ➡ NOTICE:** To avoid electrostatic discharge, ground yourself by using a wrist grounding strap or by periodically touching an unpainted metal surface (such as a connector on the back of the computer).
- ➡ NOTICE:** To help prevent damage to the system board, you must remove the battery from the battery bay before you begin working inside the computer.
-

Removing the Coin-Cell Battery

1. Follow the instructions in [Before You Begin](#).
2. Remove the system board (see [Removing the System Board](#)).
3. Turn the system board over.
4. Disconnect the coin-cell battery cable from the system board connector.
5. Remove the coin-cell battery out of the mylar sleeve.

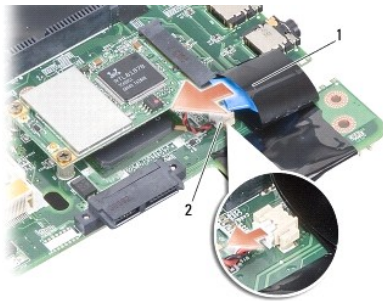

1	coin-cell battery	2	coin-cell battery cable connector
---	-------------------	---	-----------------------------------

Replacing the Coin-Cell Battery

1. Replace the coin cell battery in the mylar sleeve.
 2. Connect the coin-cell battery cable to the system board connector.
 3. Follow the instructions in [Replacing the System Board](#).
 4. Slide the main battery into the battery bay, until it clicks into place.
-

[Back to Contents Page](#)

Processor

Dell™ Inspiron™ 1410 Service Manual

- [Removing the Processor](#)
- [Replacing the Processor](#)

- ⚠ CAUTION:** Before working inside your computer, read the safety information that shipped with your computer. For additional safety best practices information, see the [Regulatory Compliance Homepage](http://www.dell.com/regulatory_compliance) at www.dell.com/regulatory_compliance.
- ➡ NOTICE:** To avoid electrostatic discharge, ground yourself by using a wrist grounding strap or by periodically touching an unpainted metal surface (such as a connector on the back of the computer).
-

Removing the Processor

- ➡ NOTICE:** To prevent intermittent contact between the ZIF-socket cam screw and the processor when removing or replacing the processor, press to apply slight pressure to the center of the processor while turning the cam screw.
- ➡ NOTICE:** To avoid damage to the processor, hold the screwdriver so that it is perpendicular to the processor when turning the cam screw.

1. Follow the instructions in [Before You Begin](#).
2. Remove the heat sink (see [Processor Heat Sink](#)).
3. To loosen the ZIF socket, use a small, flat-blade screwdriver and rotate the ZIF-socket cam screw counterclockwise until it comes to the cam stop.
The ZIF-socket cam screw secures the processor to the system board. Make a note of the arrow on the ZIF-socket cam screw.

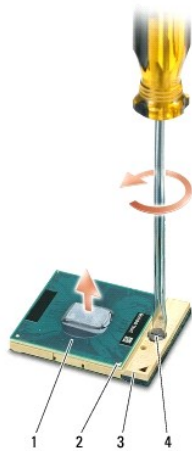

1	processor	2	pin-1 corner of processor	3	ZIF socket
4	ZIF-socket cam screw				

- ➡ NOTICE:** To ensure maximum cooling for the processor, do not touch the heat transfer areas on the processor heat sink. The oils in your skin can reduce the heat transfer capability of the thermal pads.
- ➡ NOTICE:** When removing the processor, pull it straight up. Be careful not to bend the pins on the processor.
4. Lift the processor from the ZIF socket.
-

Replacing the Processor

- ➡ NOTICE:** Ensure that the cam lock is in the fully open position before seating the processor. Seating the processor properly in the ZIF socket does not require force.
- ➡ NOTICE:** A processor that is not properly seated can result in an intermittent connection or permanent damage to the processor and the ZIF socket.

1. Align the pin-1 corner of the processor so that it points to the triangle on the ZIF socket, and insert the processor into the ZIF socket.

When the processor is correctly seated, all four corners are aligned at the same height. If one or more corners of the processor are higher than the others, the processor is not seated correctly.

 **NOTICE:** To prevent intermittent contact between the ZIF-socket cam screw and the processor when removing or replacing the processor, press to apply slight pressure to the center of the processor while turning the cam screw.

2. Tighten the ZIF socket by turning the cam screw clockwise to secure the processor to the system board.
3. Peel the backing off the thermal cooling pad and adhere the thermal pad to the portion of the processor heat sink that covers the processor.
4. Follow the instructions in [Replacing the Processor Heat Sink](#).
5. Update the BIOS using a flash BIOS-update program CD (see [Flashing the BIOS](#)).

[Back to Contents Page](#)

Processor Heat Sink

Dell™ Inspiron™ 1410 Service Manual

- [Removing the Processor Heat Sink](#)
- [Replacing the Processor Heat Sink](#)

⚠ CAUTION: Before working inside your computer, read the safety information that shipped with your computer. For additional safety best practices information, see the [Regulatory Compliance Homepage](http://www.dell.com/regulatory_compliance) at www.dell.com/regulatory_compliance

🔌 NOTICE: To avoid electrostatic discharge, ground yourself by using a wrist grounding strap or by periodically touching an unpainted metal surface (such as a connector on the back of the computer).

Removing the Processor Heat Sink

1. Follow the instructions in [Before You Begin](#).
2. Remove the system board (see [Removing the System Board](#)).
3. Turn the system board over.
4. Loosen the four captive screws on the processor heat sink.
5. Lift the processor heat sink out of the computer.

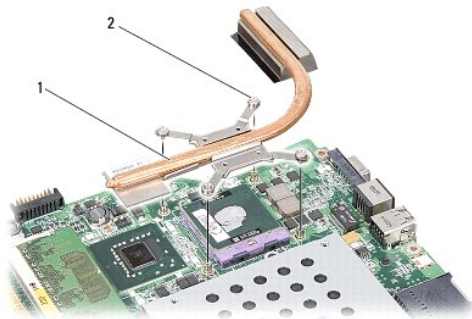

1	processor heat sink	2	captive screw (4)
---	---------------------	---	-------------------

Replacing the Processor Heat Sink

🔧 NOTE: The original thermal pad can be reused if the original processor and processor heat sink are reinstalled together. If either the processor or the processor heat sink is replaced, use the thermal pad provided in the kit to ensure that thermal conductivity is achieved.

🔧 NOTE: This procedure assumes that you have already removed the processor heat sink and are ready to replace it.

1. Peel the backing off the thermal pad and adhere the pad to the portion of the processor heat sink assembly that covers the processor.
 2. Slide the processor heat sink under the bracket and align the four captive screws with the screw holes on the system board.
 3. Tighten the four captive screws.
 4. Follow the instructions in [Replacing the System Board](#).
-

[Back to Contents Page](#)

Display

Dell™ Inspiron™ 1410 Service Manual

- [Display Assembly](#)
- [Display Bezel](#)
- [Display Panel](#)
- [Display Panel Cable](#)
- [Display Inverter](#)

- ⚠ CAUTION:** Before working inside your computer, read the safety information that shipped with your computer. For additional safety best practices information, see the Regulatory Compliance Homepage at www.dell.com/regulatory_compliance.
- 🔧 NOTICE:** To avoid electrostatic discharge, ground yourself by using a wrist grounding strap or by periodically touching an unpainted metal surface (such as a connector on the back of the computer).
- 🔧 NOTICE:** To help prevent damage to the system board, you must remove the battery from the battery bay before you begin working inside the computer.
-

Display Assembly

Removing the Display Assembly

1. Follow the instructions in [Before Working Inside Your Computer](#).
2. Remove the memory module(s) (see [Removing the Memory Module\(s\)](#)).
3. Remove the WLAN card (see [Removing the WLAN Card](#)).
4. Remove the center control cover (see [Removing the Center Control Cover](#)).
5. Remove the keyboard (see [Removing the Keyboard](#)).
6. Remove the mylar tapes and then remove the two screws from the back of the computer.



📌 NOTE: Note how the display cable is routed through their routing guides.

7. Pull the display cable tab to disconnect the display cable from the system board connector.
8. Make note of the cable routing and carefully dislodge the WLAN antenna cables and the rest of the cables from their routing guides. Pull the cables away, so that they are clear of the palm rest.

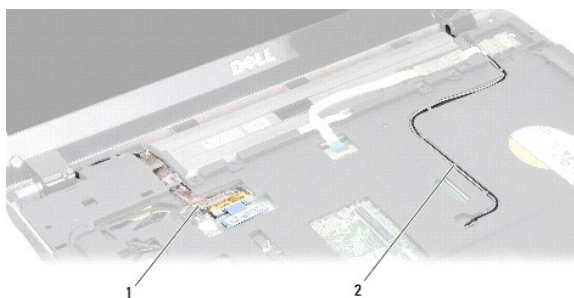

1	display cable	2	antenna cables
---	---------------	---	----------------

9. Remove the two screws from either side of the display hinges.
10. Lift and remove the display assembly.

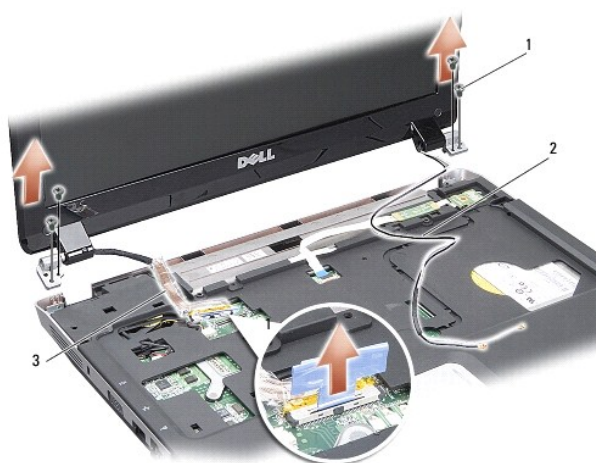

1	display hinge screw (4)	2	antenna cables
3	display cable		

Replacing the Display Assembly

⚠ CAUTION: Before working inside your computer, read the safety information that shipped with your computer. For additional safety best practices information, see the Regulatory Compliance Homepage at www.dell.com/regulatory_compliance.

1. Place the display assembly in place and replace the two screws on each side of the display hinges.
2. Re-route and connect the display cable to the connector on the system board.
3. Carefully route the WLAN antenna cables into their routing guides on the palm rest and through the computer base.
4. Replace the keyboard (see [Keyboard](#)).
5. Replace the two screws at the back of the computer.
6. Turn the computer over and carefully route the WLAN card antenna cables through their routing guides and connect them to the WLAN card.
7. Reconnect the WLAN card if applicable (see [Replacing the WLAN Card](#)).
8. Replace the memory modules (see [Replacing the Memory Module\(s\)](#)).
9. Slide the battery into the battery bay, until it clicks in place.

Display Bezel

Removing the Display Bezel

NOTICE: The display bezel is extremely fragile. Be careful when removing it to prevent damaging the bezel.

1. Remove the display assembly (see [Display](#)).
2. Remove the four rubber bumpers from the top and mylar tapes from the bottom of the display bezel.
3. Remove the six screws on the display bezel.
4. Using your fingertips, carefully pry up the inside edge of the display bezel.
5. Remove the display bezel.

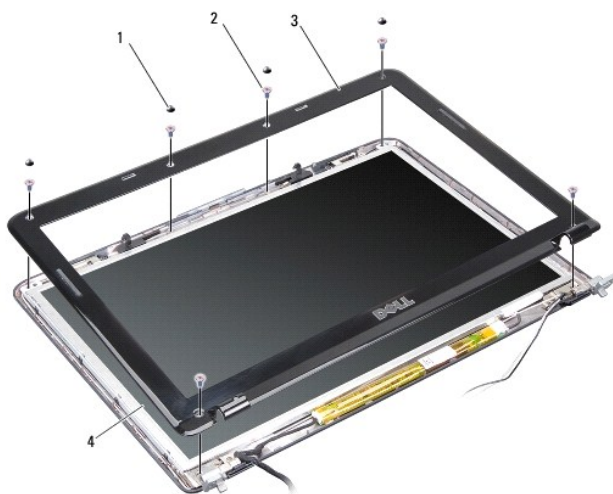

1	rubber bumper (4)	2	screw (6)
3	display bezel	4	display panel

Replacing the Display Bezel

CAUTION: Before working inside your computer, read the safety information that shipped with your computer. For additional safety best practices information, see the [Regulatory Compliance Homepage](http://www.dell.com/regulatory_compliance) at www.dell.com/regulatory_compliance.

1. Align the display bezel over the display panel, and gently snap into place.
2. Replace and tighten the six screws.
3. Replace the display assembly (see [Replacing the Display Assembly](#)).

Display Panel

Removing the Display Panel

1. Remove the display assembly (see [Display](#)).
2. Remove the display bezel (see [Removing the Display Bezel](#)).
3. Remove the six screws securing the display panel assembly to the display cover.

NOTE: Make a note of the routing of the cables behind the display panel.

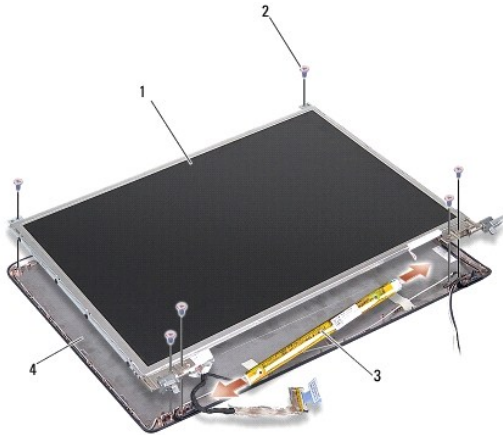

1	display panel	2	screw (6)
3	display inverter	4	display cover

4. Disconnect the cables from the connectors on each end of the inverter board.
5. Remove the display panel assembly.
6. Remove the eight screws (four on each side) that secure the display panel brackets to the display panel.



1	display panel bracket (1 left; 1 right)	2	display bracket screw (8 total; 4 on each side)
---	--	---	--

Replacing the Display Panel

CAUTION: Before working inside your computer, read the safety information that shipped with your computer. For additional safety best practices information, see the [Regulatory Compliance Homepage](http://www.dell.com/regulatory_compliance) at www.dell.com/regulatory_compliance.

1. Align the display panel brackets with the display panel.
2. Replace the eight screws that secure the display panel brackets to each side of the display panel.

3. Align the display panel with the display cover and replace the six screws.
4. Connect the display cables to the ends of the inverter board.
5. Route the cables back through their routing channels.
6. Replace the display bezel (see [Replacing the Display Bezel](#)).
7. Replace the display assembly (see [Display](#)).

Display Panel Cable

 **NOTE:** The Display Panel cables and connectors may differ depending on the Display Panel you ordered.

Removing the Display Panel Cable

1. Remove the display assembly (see [Display](#)).
2. Remove the display bezel (see [Removing the Display Bezel](#)).
3. Remove the display panel (see [Removing the Display Panel](#)).
4. Turn over the display panel and remove the conductive tape on the display board.
5. Disconnect the flex cable from the display board.



1	display board connector	2	flex cable
3	conductive tape		

Replacing the Display Panel Cable

 **CAUTION:** Before working inside your computer, read the safety information that shipped with your computer. For additional safety best practices information, see the Regulatory Compliance Homepage at www.dell.com/regulatory_compliance.

1. Connect the flex cable to the connector on the inverter board.
2. Connect the flex cable to the connector on the back of the display panel and adhere the tape back into position.
3. Replace the display panel (see [Replacing the Display Panel](#)).
4. Replace the display bezel (see [Replacing the Display Bezel](#)).
5. Replace the display assembly (see [Replacing the Display Assembly](#)).

Display Inverter

Removing the Display Inverter

1. Remove the display assembly (see [Display](#)).
2. Remove the display bezel (see [Removing the Display Bezel](#)).
3. Disconnect the cables from the connectors on either side of the inverter board.
4. Lift out the inverter board from the securing plastic tabs.

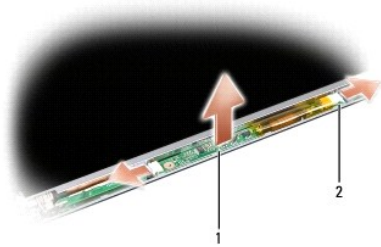

1	inverter board	2	connector (2)
---	----------------	---	---------------

Replacing the Display Inverter

⚠ CAUTION: Before working inside your computer, read the safety information that shipped with your computer. For additional safety best practices information, see the [Regulatory Compliance Homepage](http://www.dell.com/regulatory_compliance) at www.dell.com/regulatory_compliance.

1. Align the holes on the inverter board with the tabs on the display cover and snap it into position.
2. Connect the cables on either side of the inverter board.
3. Replace the display bezel (see [Replacing the Display Bezel](#)).
4. Replace the display assembly (see [Display](#)).

[Back to Contents Page](#)

System Fan

Dell™ Inspiron™ 1410 Service Manual

- [Removing the System Fan](#)
- [Replacing the System Fan](#)

CAUTION: Before working inside your computer, read the safety information that shipped with your computer. For additional safety best practices information, see the Regulatory Compliance Homepage at www.dell.com/regulatory_compliance.

NOTICE: To avoid electrostatic discharge, ground yourself by using a wrist grounding strap or by periodically touching an unpainted metal surface (such as a connector on the back of the computer).

Removing the System Fan

1. Follow the instructions in [Before You Begin](#).
2. Remove the palm rest (see [Removing the Palm Rest](#)).
3. Disconnect the fan cable from the system board connector.
4. Remove the two screws securing the system fan to the computer cover.
5. Lift the system fan out.

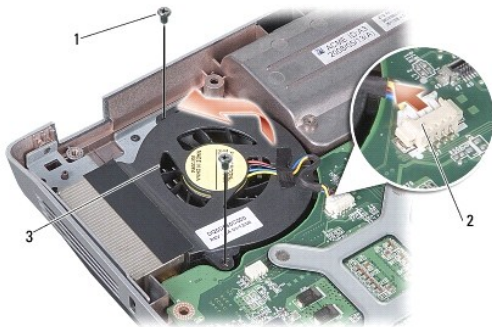

1	screw (2)	2	fan cable connector
3	system fan		

Replacing the System Fan

CAUTION: Before working inside your computer, read the safety information that shipped with your computer. For additional safety best practices information, see the Regulatory Compliance Homepage at www.dell.com/regulatory_compliance.

1. Place the system fan in position on the computer cover.
2. Replace and tighten the two screws.
3. Connect the fan cable to the system board connector.
4. Follow the instructions in [Replacing the Palm Rest](#).

[Back to Contents Page](#)

Hard Drive

Dell™ Inspiron™ 1410 Service Manual

- [Removing the Hard Drive](#)
- [Replacing the Hard Drive](#)

⚠ CAUTION: Before working inside your computer, read the safety information that shipped with your computer. For additional safety best practices information, see the Regulatory Compliance Homepage at www.dell.com/regulatory_compliance.

⚠ CAUTION: If you remove the hard drive from the computer when the drive is hot, *do not touch* the metal housing of the hard drive.

➡ NOTICE: To prevent data loss, turn off your computer (see [Turning Off Your Computer](#)) before removing the hard drive. Do not remove the hard drive while the computer is on or in Sleep state.

➡ NOTICE: Hard drives are extremely fragile. Exercise care when handling the hard drive.

🔧 NOTE: Dell does not guarantee compatibility or provide support for hard drives from sources other than Dell.

🔧 NOTE: If you are installing a hard drive from a source other than Dell, you need to install an operating system, drivers, and utilities on the new hard drive (see "Restoring Your Operating System" and "Reinstalling Drivers and Utilities" in your *Setup Guide*).

Removing the Hard Drive

1. Follow the procedures in [Before You Begin](#).
2. Remove the system board (see [Removing the System Board](#)).
3. Remove the two screws securing the hard drive assembly to the system board.

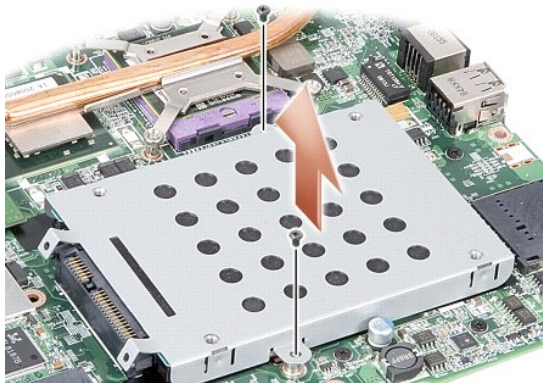

4. Holding the connector end of the hard drive assembly, pull the hard drive assembly from the system board connector.
5. Press down on the hard drive at the non-connector end slot to remove the hard drive off the hard drive cage.



1	hard drive cage	2	hard drive
---	-----------------	---	------------

➡ **NOTICE:** When the hard drive is not in the computer, store it in a protective antistatic package (see "Protecting Against Electrostatic Discharge" in the safety instructions shipped with your computer).

Replacing the Hard Drive

1. Remove the new drive from its packaging.

📌 **NOTE:** Save the original packaging for storing or shipping the hard drive.

➡ **NOTICE:** Use firm and even pressure to slide the drive into place. If you use excessive force, you may damage the connector.

2. Place the hard drive in the hard drive cage and press it down until it snaps into place.
3. Push down the hard drive assembly in place by aligning the hard drive connector with the system board connector.
4. Replace the two screws securing the hard drive assembly to the system board.
5. Replace the system board (see "[Replacing the System Board](#)").
6. Slide the battery into the battery bay, until it clicks into place.

➡ **NOTICE:** Before turning on the computer, replace all screws and ensure that no stray screws remain inside the computer. Failure to do so may result in damage to the computer.

7. Install the operating system for your computer, as needed (see "Restoring Your Operating System" in your *Setup Guide*).
8. Install the drivers and utilities for your computer, as needed (see "Reinstalling Drivers and Utilities" in your *Setup Guide*).

[Back to Contents Page](#)

Center Control Cover

Dell™ Inspiron™ 1410 Service Manual

- [Removing the Center Control Cover](#)
- [Replacing the Center Control Cover](#)

⚠ CAUTION: Before working inside your computer, read the safety information that shipped with your computer. For additional safety best practices information, see the [Regulatory Compliance Homepage](http://www.dell.com/regulatory_compliance) at www.dell.com/regulatory_compliance.

➡ NOTICE: To avoid electrostatic discharge, ground yourself by using a wrist grounding strap or by periodically touching an unpainted metal surface (such as a connector on the back of the computer).

➡ NOTICE: To help prevent damage to the system board, you must remove the battery from the battery bay before you begin working inside the computer.

Removing the Center Control Cover

1. Follow the procedures in [Before You Begin](#).
2. Turn the computer over and remove the three screws from the back of the computer.

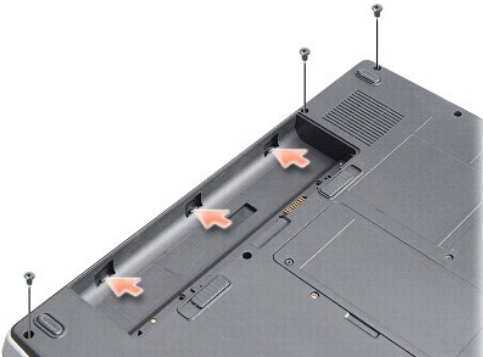

3. Turn the computer over and open the display as far as possible.

➡ NOTICE: Be extremely careful when removing the center control cover. The cable connector is very fragile.

4. Pry out the center control cover from left to right.



1	center control cover
---	----------------------

5. Remove the center control cover.

Replacing the Center Control Cover

1. Snap the center control cover in place.
 2. Turn the computer over and replace the three screws that secure the center control cover to the computer base.
 3. Replace the two screws in the battery bay.
 4. Slide the battery into the battery bay, until it clicks in place.
-

[Back to Contents Page](#)

Keyboard

Dell™ Inspiron™ 1410 Service Manual

- [Removing the Keyboard](#)
- [Replacing the Keyboard](#)

- ⚠ CAUTION:** Before working inside your computer, read the safety information that shipped with your computer. For additional safety best practices information, see the [Regulatory Compliance Homepage](http://www.dell.com/regulatory_compliance) at www.dell.com/regulatory_compliance.
- ➡ NOTICE:** To avoid electrostatic discharge, ground yourself by using a wrist grounding strap or by periodically touching an unpainted metal surface (such as a connector on the back of the computer).
- ➡ NOTICE:** To help prevent damage to the system board, you must remove the battery from the battery bay before you begin working inside the computer.
-

Removing the Keyboard

1. Follow the procedures in [Before You Begin](#).
 2. Remove the center control cover (see [Center Control Cover](#)).
 3. Remove the two screws at the top of the keyboard.
- ➡ NOTICE:** The keycaps on the keyboard are fragile, easily dislodged, and time-consuming to replace. Be careful when removing and handling the keyboard.
- ➡ NOTICE:** Be extremely careful when removing and handling the keyboard. Failure to do so could result in scratching the display panel.
4. Carefully lift the keyboard and hold it to access the keyboard connector.



1	keyboard screw (2)	2	keyboard
3	keyboard tab	4	keyboard connector

5. Lift the connector latch that secures the keyboard cable to the system board connector and remove the keyboard cable.
 6. Lift the keyboard away from the computer.
-

Replacing the Keyboard

- ➡ NOTICE:** The keycaps on the keyboard are fragile, easily dislodged, and time-consuming to replace. Be careful when removing and handling the keyboard.
1. Slide the keyboard cable into the connector and press down on the connector latch to secure the cable.
 2. Align the five tabs along the bottom of the keyboard and slide them under the palm rest.
 3. Replace the two screws at the top of the keyboard.

4. Replace the center control cover (see [Center Control Cover](#)).
5. Slide the battery into the battery bay, until it clicks into place.

[Back to Contents Page](#)

Memory Module

Dell™ Inspiron™ 1410 Service Manual

- [Removing the Memory Module\(s\)](#)
- [Replacing the Memory Module\(s\)](#)

CAUTION: Before working inside your computer, read the safety information that shipped with your computer. For additional safety best practices information, see the [Regulatory Compliance Homepage](http://www.dell.com/regulatory_compliance) at www.dell.com/regulatory_compliance.

NOTICE: To avoid electrostatic discharge, ground yourself by using a wrist grounding strap or by periodically touching an unpainted metal surface (such as a connector on the back of the computer).

You can increase your computer memory by installing memory modules on the system board. See "Specifications" in your *Setup Guide* for information on the memory supported by your computer. Install only memory modules that are intended for your computer.

NOTE: Memory modules purchased from Dell are covered under your computer warranty.

Your computer has two user-accessible SODIMM sockets that can be accessed from the bottom of the computer.

NOTICE: If you need to install memory modules in both connectors, first install a memory module in the connector located at the bottom of the computer (DIMM 1) before you install a module in the connector directly above it (DIMM 2).

Removing the Memory Module(s)

NOTICE: If a memory module is installed in the DIMM 2 connector, remove it prior to removing the memory module from the DIMM 1 connector. Failure to do so could result in damaging both memory modules.

1. Follow the procedures in [Before You Begin](#).
2. Remove the module cover (see [Module Cover](#)).

NOTICE: To prevent damage to the memory module connector, do not use tools to spread the memory module securing clips.

3. Use your fingertips to carefully spread apart the securing clips on each end of the memory module connector until the module pops up.
4. Remove the module from the connector.

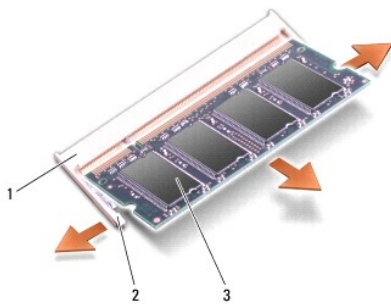

1	memory module connector	2	securing clip (2)
3	memory module		

Replacing the Memory Module(s)

1. Align the notch in the module edge connector with the tab in the connector slot.
2. Slide the module firmly into the slot at a 45-degree angle, and rotate the module down until it clicks into place. If the module does not click into place, remove the module and reinstall it.

NOTE: If the memory module is not installed properly, the computer may not boot.

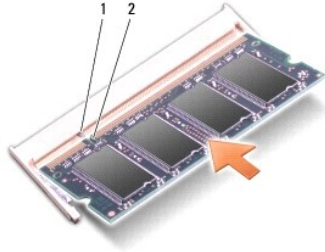

1	tab	2	notch
---	-----	---	-------

3. Replace the module cover (see [Replacing the Module Cover](#)).
4. Insert the battery into the battery bay, or connect the AC adapter to your computer and an electrical outlet.
5. Turn on the computer.

As the computer boots, it detects the additional memory and automatically updates the system configuration information.

To confirm the amount of memory installed in the computer, click **Start**  → **Help and Support** → **Dell System Information**.

[Back to Contents Page](#)

Mini-Cards

Dell™ Inspiron™ 1410 Service Manual

- [Removing the WLAN Card](#)
- [Replacing the WLAN Card](#)

⚠ CAUTION: Before working inside your computer, read the safety information that shipped with your computer. For additional safety best practices information, see the [Regulatory Compliance Homepage](http://www.dell.com/regulatory_compliance) at www.dell.com/regulatory_compliance.

👉 NOTICE: To help prevent damage to the system board, you must remove the battery from the battery bay before you begin working inside the computer.

🔍 NOTE: If you ordered a WLAN card with your computer, the card is already installed.

🔍 NOTE: Dell does not guarantee compatibility or provide support for Mini-Cards from sources other than Dell.

Your computer supports one Mini-Card for WLAN.

Removing the WLAN Card

1. Follow the procedures in [Before You Begin](#).
2. Remove the module cover (see [Removing the Module Cover](#)).
3. Disconnect the antenna cables from the WLAN card.

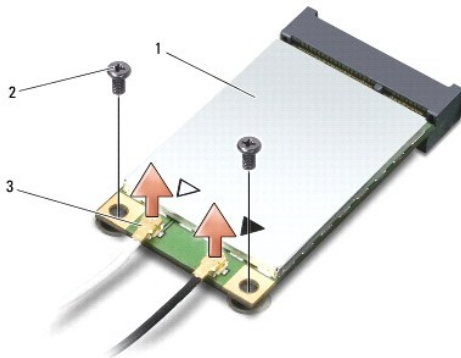

1	WLAN card	2	securing screw (2)
3	antenna cable connector (2)		

4. Remove the two securing screws from the card.
5. Lift the WLAN card out of its system board connector.

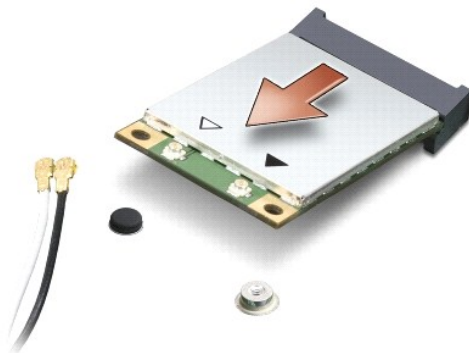

Replacing the WLAN Card

 **NOTICE:** The connectors are keyed to ensure correct insertion. If you feel resistance, check the connectors on the card and on the system board, and realign the card.

 **NOTICE:** To avoid damage to the WLAN card, never place cables under the card.

1. Follow the procedures in [Before You Begin](#).
2. Remove the new Mini-Card from its packaging.

 **NOTICE:** Use firm and even pressure to slide the card into place. If you use excessive force, you may damage the connector.

3. Insert the WLAN card connector at a 45-degree angle into the slot and press the other end of the WLAN card down.
4. Replace the two screws on the WLAN card.
5. Connect the appropriate antenna cables to the WLAN card you are installing. If the WLAN card has two triangles on the label (white and black), connect:

- 1 the white antenna cable to the connector labeled "main" (white triangle)
- 1 the black antenna cable to the connector labeled "aux" (black triangle)

If the WLAN card has three triangles on the label (white, black, and gray), connect:

- 1 the white antenna cable to the white triangle
- 1 the black antenna cable to the black triangle
- 1 the gray antenna cable to the gray triangle

 **NOTE:** The gray antenna cable may not be available in all computers. The presence of the gray antenna cable in your Mini-Card compartment depends upon the type of display.

6. Secure unused antenna cables in the protective mylar sleeve.
7. Replace the module cover (see [Replacing the Module Cover](#)) and tighten the two securing screws.
8. Slide the battery into the battery bay, until it clicks in place.
9. Install the drivers and utilities for your computer, as required. For more information, see the *Dell Technology Guide*.

 **NOTE:** If you are installing a communication card from a source other than Dell, you must install the appropriate drivers and utilities. For more information, see the *Dell Technology Guide*.

[Back to Contents Page](#)

Optical Drive

Dell™ Inspiron™ 1410 Service Manual

- [Removing the Optical Drive](#)
- [Replacing the Optical Drive](#)

CAUTION: Before working inside your computer, read the safety information that shipped with your computer. For additional safety best practices information, see the [Regulatory Compliance Homepage](http://www.dell.com/regulatory_compliance) at www.dell.com/regulatory_compliance.

NOTICE: To avoid electrostatic discharge, ground yourself by using a wrist grounding strap or by periodically touching an unpainted metal surface (such as the back panel) on the computer.

Removing the Optical Drive

NOTICE: To avoid electrostatic discharge, ground yourself by using a wrist grounding strap or by periodically touching a connector on the back panel of the computer.

1. Follow the procedures in [Before You Begin](#).
2. Remove the screw that secures the optical drive to the computer base.
3. Slide the optical drive out of the optical drive slot.



1	screw	2	optical drive
---	-------	---	---------------

Replacing the Optical Drive

1. Slide the optical drive into the slot.
 2. Replace and tighten the screw securing the optical drive.
 3. Slide the battery into the battery bay, until it clicks in place.
-

Palm Rest

Dell™ Inspiron™ 1410 Service Manual

- [Removing the Palm Rest](#)
- [Replacing the Palm Rest](#)

Removing the Palm Rest

- ⚠ **CAUTION:** Before working inside your computer, read the safety information that shipped with your computer. For additional safety best practices information, see the Regulatory Compliance Homepage at www.dell.com/regulatory_compliance.
- 🔌 **NOTICE:** To avoid electrostatic discharge, ground yourself by using a wrist grounding strap or by periodically touching an unpainted metal surface (such as the back panel) on the computer.

1. Follow the instructions in [Before You Begin](#).
2. Remove any cards from the 3-in-1 media card slot.
3. Remove the center control cover (see [Removing the Center Control Cover](#)).
4. Remove the keyboard (see [Removing the Keyboard](#)).
5. Remove the display assembly (see [Display](#)).
6. Turn the computer over and remove any installed memory modules and the WLAN card (see [Memory Module](#) and [Removing the WLAN Card](#)).
7. Remove the screw from the memory bay.
8. Remove the optical drive (see [Removing the Optical Drive](#)).
9. Remove the two screws from the optical drive bay.
10. Remove the ten screws from the computer base.

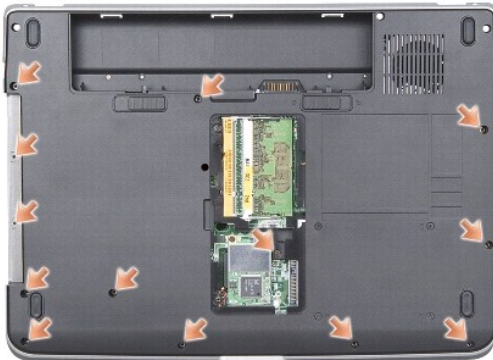

11. Turn the computer over and remove the two screws from the top of the palmrest.
12. Disconnect the power/keyboard device status light, touch pad, and display hinge connectors from the system board.
- 🔌 **NOTICE:** Carefully separate the palm rest from the computer base to avoid damage to the palm rest.
13. Starting at the top of the palm rest, use your fingers to separate the palm rest from the computer base by lifting the inside of the palm rest while pulling in on the outside.

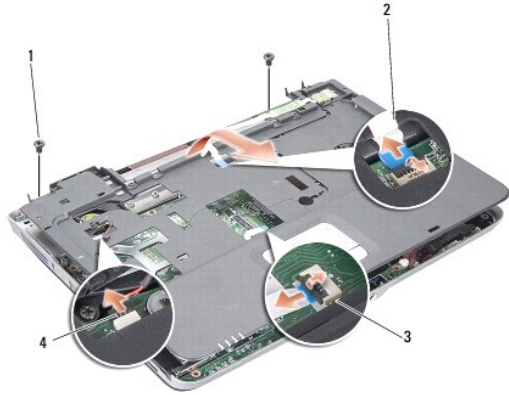

1	palmrest screw (2)	2	power/keyboard status light cable
3	touch pad cable	4	display hinge cable

Replacing the Palm Rest

1. Align the palm rest with the computer base and gently snap it into place.
2. Reconnect the power/keyboard device status light, touch pad, and display hinge cables to the respective system board connectors.
3. Replace the two screws on the top of the palm rest.
4. Turn the computer over and replace the 13 screws in the computer base.
5. Replace the display assembly (see [Replacing the Display Assembly](#)).
6. Replace the memory modules (see [Replacing the Memory Module\(s\)](#)).
7. Replace the card in the 3-in-1 card slot.
8. Replace the WLAN card (see [Replacing the WLAN Card](#)).
9. Replace the hard drive (see [Replacing the Hard Drive](#)).
10. Slide the battery into the battery bay, until it clicks in place.

[Back to Contents Page](#)

Speaker

Dell™ Inspiron™ 1410 Service Manual

- [Removing the Speaker](#)
- [Replacing the Speaker](#)

⚠ CAUTION: Before working inside your computer, read the safety information that shipped with your computer. For additional safety best practices information, see the [Regulatory Compliance Homepage](http://www.dell.com/regulatory_compliance) at www.dell.com/regulatory_compliance.

🔄 NOTICE: To avoid electrostatic discharge, ground yourself by using a wrist grounding strap or by periodically touching an unpainted metal surface (such as the back panel) on the computer.

Removing the Speaker

1. Follow the instructions in [Before You Begin](#).
2. Remove the palm rest (see [Palm Rest](#)).
3. Remove the screws that secure the speaker to the computer base.
4. Disconnect the speaker cable from the system board connector.
5. Remove the speaker.

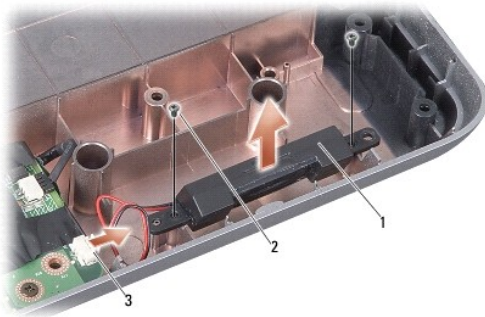

1	speaker	2	speaker screw (2)
3	speaker cable connector		

Replacing the Speaker

1. Connect the speaker cable to the system board connector.
 2. Replace the two screws that secure the speakers to the computer base.
 3. Follow the instructions in [Replacing the Palm Rest](#).
 4. Slide the battery into the battery bay, until it clicks in place.
-

System Board

Dell™ Inspiron™ 1410 Service Manual

- [Removing the System Board](#)
- [Replacing the System Board](#)

Removing the System Board

⚠ CAUTION: Before working inside your computer, read the safety information that shipped with your computer. For additional safety best practices information, see the Regulatory Compliance Homepage at www.dell.com/regulatory_compliance.

🔧 NOTICE: To avoid electrostatic discharge, ground yourself by using a wrist grounding strap or by periodically touching an unpainted metal surface (such as the back panel) on the computer.

The system board's BIOS chip contains the Service Tag, which is also visible on a barcode label on the bottom of the computer. The replacement kit for the system board includes a CD that provides a utility for transferring the Service Tag to the replacement system board.

🔧 NOTICE: Handle components and cards by their edges, and avoid touching pins and contacts.

1. Follow the instructions in [Before You Begin](#).
2. Remove any installed media cards from the 3-in-1 media card slot.
3. Remove any installed memory modules and the WLAN card (see [Memory Module](#) and [Removing the WLAN Card](#)).
4. Remove the optical drive (see [Optical Drive](#)).
5. Remove the center control cover (see [Removing the Center Control Cover](#)).
6. Remove the display assembly (see [Display](#)).
7. Remove the keyboard (see "[Removing the Keyboard](#)").
8. Remove the palm rest (see [Palm Rest](#)).
9. Remove the 3-in-1 media card reader.
10. Disconnect the system fan, speaker, RJ-11, and DC-In cables from the system board connectors.
11. Remove the system fan (see [Removing the System Fan](#)).
12. Remove the mylar tapes and then remove the four screws from the back of the computer securing the hard disk.

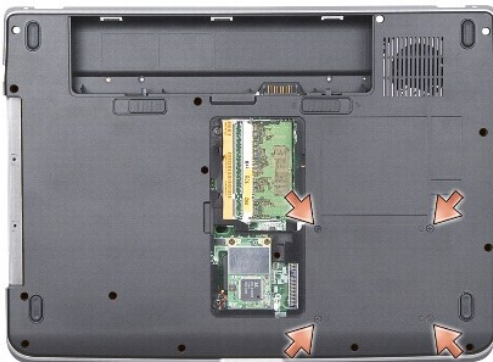

13. Remove the two remaining screws that secure the system board to the computer base.

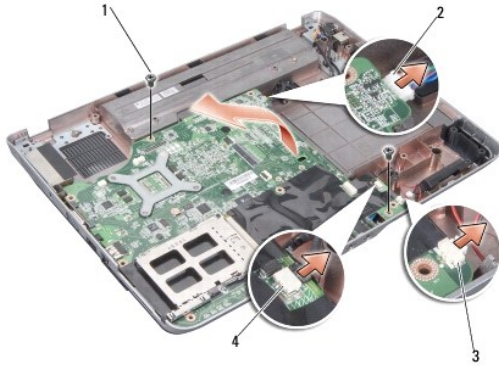

1	system board screw (2)	2	DC-In connector
3	speaker connector	4	RJ-11 connector

14. Lift the system board at an angle towards the side of the computer and out of the computer base.

Replacing the System Board

⚠ CAUTION: Before working inside your computer, read the safety information that shipped with your computer. For additional safety best practices information, see the Regulatory Compliance Homepage at www.dell.com/regulatory_compliance.

1. Follow all of the steps in [Removing the System Board](#) in reverse order.

🔁 NOTICE: Before turning on the computer, replace all screws and ensure that no stray screws remain inside the computer. Failure to do so may result in damage to the computer.

2. Slide the battery into the battery bay, until it clicks in place.

3. Turn on the computer.

🔧 NOTE: After you have replaced the system board, enter the computer Service Tag into the BIOS of the replacement system board.

4. Insert the CD that accompanied the replacement system board into the appropriate drive. Follow the instructions that appear on the screen.

[Back to Contents Page](#)